

Clearinghouse Rule 91-098

CERTIFICATE

STATE OF WISCONSIN)
) ss.
DEPARTMENT OF TRANSPORTATION)

TO ALL WHOM THESE PRESENTS SHALL COME, GREETINGS:

I, CHARLES H. THOMPSON, Secretary of the Wisconsin Department of Transportation and custodian of the official records, do hereby certify that the rule, relating to **motor vehicle equipment standards**, was duly approved and adopted by this Department on December 19, 1995.

I further certify that this copy has been compared by me with the original on file in this Department and that the same is a true copy thereof, and of the whole of such original.



IN TESTIMONY WHEREOF, I have hereunto set my hand and affixed the official seal of the Department of Transportation at 4802 Sheboygan Avenue, in the City of Madison, Wisconsin, this 19 day of **December**, 1995.

Terrence D. Mulcahy, Dep Sec
for CHARLES H. THOMPSON
Secretary

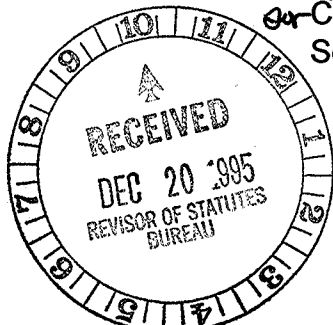

The Wisconsin Department of Transportation adopts an order to amend TRANS 149.03(4)(a)2, 149.04(3)(b) and 149.06(4)(a), relating to the inspection of a repaired salvage vehicle; to repeal ch. MVD 5; and to create ch. TRANS 305, relating to standards for vehicle equipment.

ORDER ADOPTING RULE

**Analysis Prepared by the Department of Transportation**

STATUTORY AUTHORITY: ss. 85.16(1), 110.075, 227.10(1) and 347.35(3)(b), Stats.
STATUTES INTERPRETED: ss. 342.07(2), 342.30 and chapter 347, Stats.

General Summary of Rule. This rule relates to minimum equipment requirements for vehicles and standards for the equipment used on vehicles. Included in the scope of the rule are equipment requirements for manufactured, homemade, replica, street modified and reconstructed vehicles and motor vehicles, including automobiles, light trucks, heavy trucks, motorcycles, motor homes, trailers, and semi-trailers.

The rule does not apply to farm tractors and self-propelled farm implements, implements of husbandry, vehicles drawn by animals, road machinery, bicycles, motor bicycles or mopeds, golf carts operated in accordance with s. 349.18(1)(b), Stats., homemade or reconstructed motor vehicles owned by a nonresident that are domiciled and registered in a foreign jurisdiction and temporarily operated in Wisconsin, or homemade or reconstructed vehicles registered as homemade or reconstructed vehicles in Wisconsin before January 1, 1975.

Subchapter II applies to automobiles, light trucks and motor homes; Subchapter III applies to motorcycles; and Subchapter IV applies to heavy trucks, trailers and semi-trailers. During the rule making process, the Legislature enacted 1993 Wis. Act 165 which creates two new vehicle categories eligible for special registration plates--replica vehicles and street modified vehicles. The legislation also clarified the definition of a reconstructed vehicle and provided that the equipment requirements for replica and street modified vehicles shall be the same as the vehicle equipment requirements for a vehicle of the same type and model year as the vehicle being replicated or which is not a street modified vehicle. Section Trans 305.02 on applicability of the rule was revised to reflect these statutory changes. The rule provides that homemade and reconstructed vehicles must meet the same equipment standards as would be applicable to a manufactured vehicle of the same type and model year as the year in which the homemade or reconstructed vehicle is first registered in Wisconsin. A section has also been added which explains how the Division of Motor Vehicles will title replica, street

modified, homemade and reconstructed vehicles. Homemade and reconstructed vehicles must be inspected before being registered.

The rule provides that it shall be illegal to operate a vehicle not in conformity with the requirements of the chapter. Violations are punishable by a forfeiture of not less than \$10 and not more than \$200, as provided by s. 110.075(7), Stats.

The rule continues or clarifies most provisions of ch. MVD 5, Wis. Admin. Code, relating to vehicle equipment standards. The rule also clarifies and provides additional requirements for rear end protection on light trucks; restraining devices and seats; modifications affecting height of vehicles; and equipment required for motorcycles and for heavy trucks, trailers and semitrailers. The rule clarifies and sets new requirements for tinted windows. After market application of tinting films is permitted as long as the combination of glazing and film does not exclude more than 50% of the light striking the front side windows or more than 65% of the light striking the rear side windows and rear window. A medical exemption allows the front side windows to be tinted to the same degree as the rear side windows and rear window. The same standard applies to automobiles and trucks. The Department has received permission from the Attorney General and the Revisor of Statutes under s. 227.21 to incorporate by reference the photometric standards of the Society of Automotive Engineers for auxiliary driving lamps, front fog lamps and auxiliary low beam lamps.

Fiscal Impact. This rule has no significant fiscal effect on state revenues or liabilities or on the revenues or liabilities of any county, city, village, town, school district, technical college district or sewerage district.

Final Regulatory Flexibility Analysis. This rule has no significant impact on small businesses.

Contact Person. The person to contact for further information is Michael Moore, Wisconsin State Patrol Academy at (608) 269-2500. Alternate formats of the rule will be made available to individuals at their request.

TEXT OF RULE

Under the authority vested in the Wisconsin department of transportation by ss. 85.16(1), 110.075, 227.10(1) and 347.35(3)(b), Stats., the department of transportation hereby repeals ch. MVD 5 and creates ch. Trans 305, Wis. Admin. Code, implementing ss. 110.075, 341.10(6), 341.268 and 342.06, and ch. 347, Stats., as follows:

SECTION 1. Chapter MVD 5 is repealed.

SECTION 2. Chapter Trans 305 is created to read:

CHAPTER TRANS 305
STANDARDS FOR VEHICLE EQUIPMENT

SUBCHAPTER I

GENERAL PROVISIONS

TRANS 305.01 PURPOSE AND SCOPE. (1) The purpose of this chapter is to prescribe minimum equipment requirements for vehicles and standards for the equipment used on vehicles.

(2) This chapter includes equipment requirements for manufactured, homemade, street modified, replica and reconstructed vehicles and motor vehicles, including automobiles, light trucks, heavy trucks, motorcycles, motor homes, trailers and semi-trailers.

TRANS 305.02 APPLICABILITY. (1) This chapter does not apply to the following vehicles:

- (a) Farm tractors and self-propelled farm implements.
- (b) Implements of husbandry as defined in s. 340.01(24), Stats.
- (c) Vehicles drawn by animals.
- (d) Road machinery.
- (e) Bicycles.
- (f) Motor bicycles or mopeds.
- (g) Golf carts operated in accordance with s. 349.18(1)(b), Stats.
- (h) Homemade, street modified, replica or reconstructed motor vehicles owned by a nonresident that are domiciled and registered in a foreign jurisdiction and temporarily operated in Wisconsin.

(i) Homemade or reconstructed vehicles registered as homemade or reconstructed vehicles in Wisconsin before January 1, 1975.

(2) Except as provided in sub. (4):

(a) Subchapter II applies to automobiles, light trucks and motor homes.

(b) Subchapter III applies to motorcycles.

(c) Subchapter IV applies to heavy trucks, trailers and semi-trailers.

(3) Homemade or reconstructed vehicles registered in Wisconsin on or after January 1, 1975, shall meet the vehicle equipment standards in subchs. II, III and IV applicable to vehicles of the same type which are manufactured in the year in which the homemade or reconstructed vehicle is first registered in Wisconsin except as specifically provided. When subchs. II, III and IV make equipment standards applicable to vehicles manufactured after a certain date, the standards apply to homemade and reconstructed vehicles first registered in Wisconsin after that date.

(4) Vehicles covered under subchs. II, III and IV that are street modified or replica vehicles shall meet the following vehicle equipment requirements:

(a) The vehicle equipment requirements for a street modified vehicle shall be the same as the vehicle equipment requirements for a vehicle of the same type and model year that is not a street modified vehicle.

(b) The vehicle equipment requirements for a replica vehicle shall be the same as the vehicle equipment requirements for a vehicle of the same type and model year as the vehicle used for purposes of the reproduction.

(5) No section of this chapter requires vehicles meeting equipment requirements established by Wisconsin or federal law for the year of original manufacture to update

vehicle equipment to meet increased requirements under this chapter unless updating is required by ch. 347, Stats., or sub. (3).

(6) Vehicles that were legally titled and registered in another jurisdiction and that met vehicle equipment standards established by the law of the other jurisdiction shall not be required to update vehicle equipment to meet increased requirements under this chapter upon titling and registration in Wisconsin unless updating is required by ch. 347, Stats.

(7) Nothing in this chapter is intended to modify the provisions of ch. 347, Stats., and all vehicles to which this chapter applies shall also comply with the requirements of ch. 347, Stats.

(8) Nothing in this chapter is intended to modify the provisions of chs. Trans 308, 325, 326, 327 and 328, and all vehicles to which subchapter IV applies shall also comply with all applicable requirements of chs. Trans 308, 325, 326, 327 and 328.

TRANS 305.03 ENFORCEMENT. No person may operate or allow to be operated on Wisconsin highways any vehicle subject to this chapter that is not in conformity with the applicable requirements of this chapter. Whenever this chapter requires a lamp or device to be mounted at a certain height, the distance shall be measured from the center of the lamp or device to the level ground upon which the vehicle stands when such vehicle is without load.

TRANS 305.04 PENALTY. Unless a different penalty is provided by statute, any violation of this chapter shall be punishable as prescribed in s. 110.075(7), Stats.

TRANS 305.05 DEFINITIONS. Words and phrases defined in chs. 340 and 341, Stats., are used in the same sense in this chapter unless a different definition is specified. In this chapter:

(1) "Adverse weather lamp" has the meaning provided in s. 340.01(1m), Stats.

(2) "Air pollution control equipment" has the meaning provided in s. 144.42(6), Stats.

(3) "Auxiliary lamp" means any lamp mounted on a vehicle with a bulb having wattage in excess of 10 watts and which is not required equipment under ch. 347, Stats., or this chapter, except a spot lamp. Auxiliary lamps may include adverse weather lamps, fog lamps, driving lamps and off-road lamps.

(4) "Back-up lamp" means any lamp designed to provide road illumination to the rear of a vehicle when the vehicle is in reverse gear.

(5) "Braking system" means the components required to stop a motor vehicle including the braking pedal, master cylinder, connecting hoses, lines, fluids, linkage, drums, shoes, rotors, pads, calipers and parking brake.

(6) "Bumper" means a device mounted at the front or rear of a vehicle for absorbing shock and providing a contact point that may reduce damage to the vehicle in a collision.

(7) "Designated seating position" has the meaning provided in 49 CFR 571.3.

(8) "Driver's compartment" means the interior part of the vehicle designed for use by the vehicle operator while controlling the movement of the vehicle.

(9) "Driving lamp" means an auxiliary lamp which projects a fixed narrow beam of light intended to illuminate objects beyond the normal distance illuminated by headlamps.

(10) "Exhaust system" means all components used on a motor vehicle for discharging exhaust fumes including mufflers.

(11) "Federal clean air act" has the meaning provided in s. 144.42(1)(a), Stats.

(12) "Fender" means a guard or covering over the wheels of a vehicle to prevent the splashing of water, mud or other materials which may be thrown by the wheels.

(13) "Firewall" means that portion of the vehicle separating the passenger compartment from the engine compartment.

(14) "Floor pan" means that portion of a vehicle separating the passenger and trunk compartments from the road beneath a vehicle.

(15) "Fog lamp" means an auxiliary lamp using a fluted lens which projects a wide-angle beam of light intended to illuminate objects 400 to 700 feet in front of a vehicle. This lamp is also referred to as an adverse weather lamp.

(16) "Frame" means the structure which supports the body, drive train, steering mechanism and axles of the vehicle. The frame includes the structural components of unibodies and may include chassis components if they are an integral part of the structural integrity of the vehicle.

(17) "Fuel system" includes the fuel tank, cap, filler pipe, pump, carburetor, injector systems and all accompanying components.

(18) "Hazard warning lamps" means lamps that flash simultaneously to the front and rear on both the right and left sides of a motor vehicle to warn motorists of a hazard.

(19) "Heavy truck" means a motor truck, truck tractor, or road tractor with a gross vehicle weight rating, registered weight or actual gross weight of more than 10,000 pounds. The term also includes any combination vehicle where one of the vehicles in the combination is a motor truck, truck tractor or road tractor and the gross combination

weight rating, registered weight or actual weight of the combination exceeds 10,000 pounds.

(20) "High-mounted stop lamp" means an additional lamp of a stop lamp system giving a brake-actuated, steady warning light to the rear of the vehicle intended to provide a signal to both the operator of the next following vehicle and through intervening vehicles to the operators of the other following vehicles.

(21) "Homemade vehicle" has the meaning provided in s. 341.268(1)(b), Stats.

(22) "Horn" means a warning device, mounted on a motor vehicle, which produces audible sound.

(23) "Immediate family member" means a spouse, child, stepchild, foster child or other dependent if the spouse, child, stepchild, foster child or other dependent resides in the household of the owner of a motor vehicle.

(24) "Incomplete vehicle" means an assemblage consisting, as a minimum, of frame and chassis structure, power train, steering system, suspension system, and braking system to the extent that those systems are to be part of the completed vehicle that requires further manufacturing operations, other than the addition of readily attachable components, such as mirrors or tire and rim assemblies, or minor finishing operations such as painting, to become a completed vehicle.

(25) "Incomplete vehicle manufacturer" means a person who manufactures an incomplete vehicle by assembling components, none of which, taken separately, constitute a complete vehicle.

(26) "Lash" means the condition in which the steering wheel may be turned through some part of a revolution without associated movement of the wheel or wheels that turn the vehicle.

(27) "Light truck" means a motor truck, truck tractor, road tractor or combination vehicle with a gross vehicle weight rating, registered weight or actual gross weight of 10,000 pounds or less.

(27m) "Manufactured" means produced by a manufacturer of vehicles as defined in s. 340.01(28), Stats.

(28) "Nontransparent materials" means all materials, including those that may be sprayed or painted, on motor vehicle glazing, which reduce the amount of visible light passing through the motor vehicle glazing material or otherwise restrict or distort the clear view of any object or person. The term does not include tinted films applied to the interior or exterior surface of motor vehicle glazing material.

(29) "Parking lamps" means 2 lamps mounted on the front of a motor vehicle, one on each side, designed to mark the front of the vehicle when parked.

(30) "Reconstructed vehicle" has the meaning provided in s. 341.268(1)(d), Stats.

(31) "Registration plate lamp" means a lamp designed to illuminate the rear registration plate of a vehicle.

(32) "Replica vehicle" has the meaning provided in s. 341.268(1)(e), Stats.

(33) "Restraining device" means any device designed to secure persons in the seat of a motor vehicle, including safety belts and airbags, in order to mitigate the results of any accident.

(34) "Safety belt" has the meaning provided in s. Trans 310.02(3).

(35) "Shock absorbing device" means an energy dissipating device on a vehicle which increases vehicle stability and improves steering, handling and ride performance. It includes shock absorbers and struts.

(36) "Side marker lamps" means lamps used on each side of a vehicle to indicate its length and to make the vehicle visible when approaching from the side.

(36m) "Semitrailer" and "trailer" have the meaning provided in ss. 340.01(57) and (71), Stats., except that for purposes of this chapter, the terms include mobile homes.

(37) "SAE" means the society of automotive engineers.

(38) "Steering wheel" means a circular device mounted on the steering shaft in the driver's compartment of a motor vehicle, other than a motorcycle, for use by the driver to maneuver the steering system of a motor vehicle.

(39) "Street modified vehicle" has the meaning provided in s. 341.268(1)(f), Stats.

(40) "Suspension system" means that portion of a vehicle between the frame and the axles including, but not limited to, springs, torsion bars, shackles, shock absorbers, cross stabilization bars, anti-sway bars, and all attachment parts.

(41) "Tire and rim" means the rubber tire and its mounting surface on which the vehicle is suspended. The component parts are defined as follows:

(a) "Bead" means the part of the tire which is shaped to fit the rim, made of high-tensile steel wire wrapped and reinforced by the plies.

(b) "Belt" means the layer or layers made of fabric or other material located under the tread area.

(c) "Cord" means the textile or steel wire strands, or the like, forming the plies or other structure of the tire.

(d) "Groove" means the space between 2 tread ribs.

(e) "Major tire groove" means the circular grooves where the wear indicator bars are located.

(f) "Ply" means the layer of rubber-coated parallel strands or cords forming the tire body.

(g) "Rib" means the tread section running around the circumference of the tire.

(h) "Rim" means the metal support for tire and tube assembly. Tire beads are seated on the rim.

(i) "Sidewall" means the portion of the tire between tread and bead.

(j) "Tread" means the portion of the tire that comes in contact with the road.

(42) "Windshield" means the transparent shield of safety glass mounted forward of the passenger compartment of a motor vehicle other than a motor driven cycle.

(43) "Windshield critical area" means that portion of a motor vehicle windshield normally used by the driver for necessary observations to the front of the vehicle. This includes the areas normally swept by a factory installed windshield wiper system.

TRANS 305.06 IDENTIFICATION OF VEHICLES. No person may operate a vehicle on a highway if:

(1) The vehicle identification number is missing, obliterated, altered or not properly attached.

(2) The vehicle is a homemade, reconstructed or replica vehicle and does not have a vehicle identification number assigned by a manufacturer or by the department.

Trans 305.065 HOMEMADE, REPLICA, STREET MODIFIED, RECONSTRUCTED AND OFF-ROAD VEHICLES. (1) INSPECTION. Upon completion of assembly or reconstruction, every homemade or reconstructed vehicle shall be inspected prior to being registered or titled for compliance with this chapter and ch. 347, Stats. The inspection shall be performed by an inspector authorized by the department to perform inspections of salvage vehicles under s. 342.07, Stats.

(2) TITLES. (a) Homemade and reconstructed vehicles. The department shall issue a title indicating that a vehicle is a homemade or reconstructed vehicle where the make of the vehicle would otherwise be shown on the title. The model year shown on the title shall match the calendar year of the inspection performed under this section.

(b) Replica and street modified vehicles. The department shall issue a title indicating that a vehicle is a replica or street modified vehicle and the make and model year shown on the title shall be the original make and model year of the street modified vehicle or the make and model year of the vehicle being replicated. The installation of reproduction body parts on a previously manufactured and titled vehicle body and frame shall not be considered by the department to constitute a replica vehicle for purposes of identifying the vehicle on its title. A vehicle shall be considered a replica or a street modified vehicle if it has been certified by the owner to be a replica or a street modified vehicle for purposes of registration under s. 341.268, Stats. A vehicle shall also be considered a street modified vehicle if the vehicle's engine has been replaced with one which required adaptation beyond ordinary replacement.

(3) REGISTRATION. As provided in s. 341.10(6), Stats., no vehicle originally designed and manufactured for off-highway use may be registered by the department unless it bears the label required by s. 114 of the national traffic and motor vehicle safety act of 1966, as amended. The label shall be affixed by the original manufacturer and shall certify that at the time of manufacture the vehicle met all applicable federal motor vehicle safety standards. Vehicles generally not eligible to be registered include, but are not limited to, mini-bikes, go-carts and all-terrain vehicles.

NOTE: Section 114 of the National Traffic and Motor Vehicle Safety Act of 1966, as amended, is codified as 15 U.S.C. s. 1403. 49 CFR Part 567 establishes standards for the location and contents of the required label.

**SUBCHAPTER II
AUTOMOBILES, MOTOR HOMES AND LIGHT TRUCKS**

TRANS 305.07 DEFINITIONS. For purposes of this subchapter, "motor vehicle" means automobiles, motor homes and light trucks.

TRANS 305.075 AUXILIARY LAMPS. (1) Auxiliary lamps that are fog lamps or adverse weather lamps may not be used in lieu of headlamps during those times when headlamps are required except as expressly allowed by s. 347.26(3), Stats. Other auxiliary lamps shall not be used in lieu of headlamps.

(2) Unless specifically permitted by this chapter or by ch. 347, Stats., no motor vehicle may be operated upon a highway with a lighted auxiliary lamp unless the auxiliary lamp:

(a) Is mounted below the level of the center of the headlamps, except that when added equipment, such as a snow plow blocks the transmission of light from factory installed headlights, alternate headlights may be mounted above the factory installed headlights and may temporarily be used during the time the light obstructing equipment is in place.

(b) Directs light forward of the vehicle.

(c) Meets the photometric specifications in SAE technical reports J581, J582 and J583 for auxiliary driving lamps, auxiliary low beam lamps or front fog lamps.

NOTE: SAE Standard J581 was approved in March 1979 and completely revised by the Lighting Coordinating Committee in June 1989. SAE Recommended Practice J582 was approved in January 1981 and completely revised by the Lighting Committee in September 1984. SAE Standard J583 was approved in May 1937 and completely revised by the Lighting Committee in July 1977 with an editorial change in May 1981. The SAE standards, published in the 1994 SAE Handbook, are available in the offices of the Department of Transportation, the Secretary of State, and the Revisor of Statutes. These standards may also be purchased from the Society of Automotive Engineers, Inc., 400 Commonwealth Drive, Warrendale, PA 15096-0001.

(3) Whenever the operator of a vehicle equipped with auxiliary lamps projecting a beam beyond that of the vehicle's low beam headlamps approaches an oncoming vehicle within 500 feet, or approaches or follows another vehicle within 500 feet, the operator shall extinguish the auxiliary lamps in order to prevent glaring rays being directed into the eyes of the operator of another vehicle.

(4) Adverse weather lamps shall be mounted below a horizontal line between the centers of the headlamps. If equipped with 2 adverse weather lamps, they shall be mounted on the same horizontal plane and on opposite sides of the center of the vehicle.

(5) Motor vehicles may be equipped with auxiliary off-road lamps that may face to the front or rear of the vehicle. The lamps shall be wired independently of all other lighting circuits and, whenever the vehicle is operated or driven upon a highway, shall be covered or hooded with an opaque hood or cover and turned off.

TRANS 305.08 BACK-UP LAMP. (1) Every motor vehicle originally equipped with back-up lamps and every motor vehicle originally manufactured after January 1, 1969, shall be equipped with back-up lamps in proper working condition and in conformity with this section and s. 347.26(4), Stats.

(2) The back-up lamp wiring and connections shall be maintained in good condition.

(3) Back-up lamps may be activated by a switch on the transmission system so the lamps can be lighted only when the transmission is in reverse gear or may be manually turned on by a switch in the driver's compartment providing there is an indicator light plainly visible to the vehicle driver indicating when the back-up lamps are on.

TRANS 305.09 DIRECTION SIGNAL LAMPS. (1) The front and rear direction signal lamp system of every motor vehicle manufactured after January 1, 1955, shall be maintained in proper working condition and in conformity with this section and s. 347.15, Stats.

(2) All self-canceling direction signal switches shall be in proper working condition.

(3) All direction signal indicator lamps shall be installed and maintained in proper working condition and may not be covered or obscured by any object or material.

(4) All wiring and connections shall be maintained in good condition.

(5) There shall be no cracked, broken or missing lenses or reflectors.

TRANS 305.10 HAZARD WARNING LAMPS. (1) Every motor vehicle originally equipped with hazard warning lamps and every motor vehicle originally manufactured after January 1, 1969, shall be equipped with hazard warning lamps in proper working condition and in conformity with this section and s. 347.26(11), Stats.

(2) Hazard warning lamps shall be securely mounted.

(3) Hazard warning lamp wiring and connections shall be maintained in good condition.

TRANS 305.11 HEADLAMPS. (1)(a) Every motor vehicle shall be equipped with a headlamp system meeting the specifications of the headlamp system with which the vehicle was originally manufactured. Every homemade or reconstructed vehicle shall be equipped with a headlamp system meeting the specifications of headlamp systems on vehicles manufactured in the year in which the homemade or reconstructed vehicle is first registered.

(b) Every headlamp shall be properly aimed so as to conform with manufacturer's recommendations and so that glaring light rays from the headlamp are not directed into the eyes of the driver of any oncoming vehicle.

(2)(a) The headlamp system on every motor vehicle shall be maintained in proper working condition and in conformity with this section and ss. 347.09 and 347.10, Stats.

(b) The headlamp switch, dimmer switch and beam indicator shall be in proper working condition. All wiring and connections shall be in good condition.

(3)(a) Every motor vehicle shall have an equal number of headlamps on each side of the vehicle installed at least 12 inches from the center of the vehicle and at the height specified in s. 347.09(2), Stats.

(b) Every headlamp shall be properly installed, adjustable and securely fastened. The headlamp mounting shall be in good condition.

(c) No headlamp may have any type of cover that in any way tints the emitted light or reduces the amount of light emitted to below that required by s. 347.10, Stats. This paragraph applies only at times when the use of headlights is required.

TRANS 305.12 PARKING LAMPS. (1) Every motor vehicle manufactured commencing with the 1950 models, and every homemade or reconstructed motor vehicle registered on or after January 1, 1975, shall be equipped with parking lamps to the front meeting the visibility requirements of s. 347.27(l)(b), Stats.

(2) The parking lamps and lens of every motor vehicle shall be maintained in proper working condition and in conformity with this section and s. 347.27, Stats.

(3) All wiring and connections shall be maintained in good condition.

TRANS 305.13 REGISTRATION PLATE LAMP. (1) All registration plate lamps, wiring and connections shall be maintained in proper working condition and in conformity with this section and ss. 347.13(3) and (4), Stats.

(2) The registration plate lamp shall be so constructed and placed as to prevent light from the lamp shining away from the vehicle.

TRANS 305.14 SIDE MARKER LAMPS, CLEARANCE LAMPS AND REFLECTORS. (1) Every motor vehicle originally equipped with side marker lamps, every motor vehicle manufactured after January 1, 1969, every vehicle registered as a homemade vehicle on or after January 1, 1975, and every vehicle registered as a reconstructed vehicle after [Revisor insert the effective date of this chapter] shall be equipped with side marker lamps and reflectors marking at least the front and rear corners of the vehicle.

(2) Every motor vehicle originally equipped with clearance lamps as defined in s. 340.01(7), Stats., or reflectors shall have such lamps or reflectors maintained in conformity with this section and with ss. 347.16 to 347.19, Stats.

(3) Side marker lamp and clearance lamp wiring and connections shall be maintained in good condition.

(4) Side marker lamps, clearance lamps and reflectors shall be securely mounted and maintained in proper working condition.

TRANS 305.15 STOP LAMPS. (1) Every motor vehicle originally manufactured with 2 stop lamps, every automobile originally manufactured commencing with the 1950 models, every light truck or motor home originally manufactured commencing with the 1955 models, and every homemade or reconstructed vehicle registered on or after January 1, 1975, shall be equipped with at least 2 stop lamps. All other motor vehicles shall be equipped with at least one stop lamp.

(2) The stop lamps of every vehicle shall be maintained in proper working condition and in conformity with this section and s. 347.14, Stats.

(3) All wiring and connections shall be maintained in good condition.

(4) All stop lamp lenses shall be installed and maintained in proper condition and may not be covered or obscured by any object or material.

(5) The high-mounted stop lamp of every motor vehicle originally manufactured with a high-mounted stop lamp shall be maintained in proper working condition and shall not be covered or obscured by any object or material. Camper tops and other similar coverings may be placed over the cargo area of a light truck provided that if a high-mounted stop lamp is installed on or in the cab of the truck, a comparable high-mounted stop lamp shall be installed on the rear of the truck and maintained in proper working condition. This subsection does not apply to the temporary covering or obscuring of a high mounted stop lamp by property carried on or in the motor vehicle or in a trailer towed by the motor vehicle.

TRANS 305.16 TAIL LAMPS. (1) Every motor vehicle originally manufactured with 2 tail lamps, every automobile originally manufactured commencing with the 1950 models, every light truck or motor home originally manufactured commencing with the 1955 models, and every homemade or reconstructed vehicle registered on or after January 1, 1975, shall be equipped with 2 tail lamps. All other motor vehicles shall be equipped with at least one tail lamp.

(2) The tail lamps of every motor vehicle shall be maintained in proper working condition and in conformity with this section and ss. 347.13(1) and (2), Stats.

(3) All wiring and connections shall be maintained in good condition.

(4) All tail lamp lens and reflectors shall be installed and maintained in proper condition and may not be covered or obscured by any object or material.

(5) The tail lamps shall be so wired as to be lighted whenever the parking lamp or headlamps are lighted.

TRANS 305.17 BRAKES. (1) The brake system on every motor vehicle shall be maintained in proper working condition and in conformity with this section and s. 347.36, Stats.

(2) Every motor vehicle shall have:

(a) Braking ability on every wheel.

(b) No noticeable side pull or excessive vibration when the brakes are applied.

(c) Brake pedals with a reserve of no less than 20 percent of total pedal travel left when fully depressed.

(d) A brake system fully connected and free of leaks.

(e) Linings, pads, drums and rotors that all meet manufacturer's minimum recommendations.

(f) An adequate parking brake meeting the requirements of s. 347.35, Stats.

(3) All replacement brake lines shall be made only of materials meeting or exceeding the specifications of the brake system manufacturer.

TRANS 305.18 BUMPERS. (1)(a) Every motor vehicle originally manufactured with bumpers, and every motor vehicle manufactured after September 1, 1972, and required by federal law to be equipped with bumpers or crash resistance protection, or both, shall be equipped with bumpers which shall be maintained in good condition and in conformity with this section. Replacement equipment shall be the same type as originally required or of equivalent size, strength and surface area. The bumpers may

be mounted externally on the vehicle or installed within the front and rear extremes of the vehicle.

(b) Every homemade or reconstructed motor vehicle registered after January 1, 1975, shall be equipped with front and rear bumpers which provide damage protection that is equivalent to that provided by the bumpers of vehicles manufactured for sale in the year the homemade or reconstructed vehicle is first registered. Such bumpers may be mounted externally on the vehicle or installed within the front and rear extremes of the vehicle. Homemade and reconstructed vehicles registered in Wisconsin prior to [Revisor...enter date of rule] may comply with either this section or the previous rules governing homemade vehicles.

(c) Light trucks manufactured on or after [Note to Revisor...January 1 of the first year after the effective date of this chapter] are required to have rear end protection in accordance with s. Trans 305.56. Light trucks operated under s. 341.47(1), Stats., are exempt from the requirements of this paragraph.

(2)(a) All required bumpers shall be securely mounted to the vehicle and at a height that does not vary from the manufacturer's specifications by more than is permitted under s. 347.455, Stats. In the absence of manufacturer's specifications, every required bumper shall provide a contact point no higher than 30 inches from the level surface on which the vehicle stands.

(b) No required bumper may be constructed of wood except that an additional wood bumper may be added to a legal metal bumper.

(c) No bumper may be damaged or distorted so that it projects away from the vehicle in a manner which creates a hazard.

TRANS 305.19 DOORS, HOODS, LOCKS AND LATCHES. (1) All locks, latches and hinges on every door, hood and trunk lid of a motor vehicle shall be maintained in proper working condition. Each door, hood and trunk lid shall be equipped with sufficient hinges and latches so it can be securely closed.

(2)(a) Every motor vehicle, except those manufactured with removable doors or without doors, shall be equipped with doors. Open top designed vehicles are not required to have operating doors when the vehicle is operated without a top.

(b) The hood or engine of a vehicle shall have no protrusions that will restrict the driver's view over the fender and front line of the vehicle by more than 3 inches while seated in the driver's position.

(3) A trunk lid or hatchback may be temporarily secured in an open position when transporting oversized objects that prevent complete lid closure.

(4) Nothing in this section prohibits the interior door handles of the rear door or side rear doors being intentionally made inoperative.

TRANS 305.20 EXHAUST AND AIR POLLUTION CONTROL SYSTEMS.

(1) The exhaust system on every motor vehicle shall be maintained in proper working condition and in conformity with this section and s. 347.39, Stats.

(2) Piping used in exhaust systems shall be of the rigid type. Convolute pipe meets this requirement, but flexible tubing may not be used in the exhaust system.

(3) Every exhaust system located so as to be hazardous to a person outside the vehicle or to a person entering or leaving a vehicle shall be protected in order to prevent such person from being burned or otherwise injured. The exhaust system location shall be considered hazardous if it extends beyond the body line for those systems where the exhaust pipes are on or extend to the side of the vehicle. A system where the exhaust

pipes extend upward along the side or rear of the body shall also be protected in order to prevent persons from being burned or otherwise injured.

(4) The muffler and all parts of the exhaust system shall be functioning and may not be repaired by an inadequate patch or improperly discharge fumes.

(5) The tail pipe shall extend to the outside body line of the vehicle, except that light trucks may have the exhaust outlet extend only to the rear of the vehicle cab if the cargo area is not enclosed and used for passenger transportation.

(6) The exhaust system shall not be modified so as to pass through the passenger compartment.

(7) All air pollution control equipment required by the federal clean air act and its implementing regulations shall remain installed or be replaced with identical or comparable tested parts. Air pollution control equipment originally installed by the manufacturer or identical or comparable tested replacement equipment may not be removed, disconnected or physically altered to be ineffective.

(8) All air pollution control equipment required under sub. (7) shall be maintained in proper working condition and in conformity with s. 144.42(6), Stats.

TRANS 305.21 FLOOR PAN AND FIREWALL. (1) The floor pan of every motor vehicle shall be maintained in good condition and in conformity with this section.

(2) The floor pan shall be free of rusted areas or holes which may allow entry of exhaust gases or would not adequately support vehicle occupants or cargo.

(3) No motor vehicle body may be raised above the frame more than 4 inches beyond the original manufacturer's specifications. In the absence of such specifications, and on homemade and reconstructed vehicles, no body may be mounted with the floor pan more than 4 inches above the frame.

(4) The firewall shall be maintained free of any holes. Any mechanisms, cables or wires routed through the firewall shall be properly sealed to prevent the entry of exhaust gases into the passenger compartment.

TRANS 305.22 FENDERS AND PROJECTING PARTS. (1) Every motor vehicle originally manufactured after January 1, 1950, every homemade vehicle registered after January 1, 1975, and every vehicle registered as a reconstructed vehicle after [Revisor...insert date of rule] shall be equipped with adequate fenders covering the front and rear tires to prevent splashing of water and throwing of gravel, stones or other objects.

(2) All fenders shall be free of severely rusted or damaged material which may cause injury or cause the fenders to be ineffective. All required fenders shall be of sufficient width and length to cover the tire tread from 15 degrees to the front to 60 degrees to the rear when measured at the center of the axle, to the top of the tire, on a vertical plane.

(3) All fenders shall be securely mounted.

(4) Fenders may be extended up to 4 inches beyond the original fender line or the manufacturer's optional equipment fender flare line in order to cover tires that also extend beyond the original fender or flare line.

(5) No part of the vehicle or any vehicle accessory shall project away from the vehicle in a hazardous manner.

TRANS 305.23 FRAMES. (1) The frame on every motor vehicle shall be maintained in proper condition and in conformity with this section.

(2) Repairs, modifications or additional frame support are acceptable if they do not reduce the structural integrity or affect the alignment of the vehicle. Braze type welding may not be used on any repairs made to the frame.

(3) The frame may not be rusted or twisted to the extent that it no longer properly supports the vehicle or no longer provides the structural integrity necessary for correct alignment or safety.

(4) The vehicle may not be noticeably out of alignment due to inadequate or improper repair or modification of the frame.

(5) No part of the frame may be missing due to excessive rust or uncorrected damage.

TRANS 305.24 FUEL SYSTEMS. (1) The fuel system of every motor vehicle shall be in proper working condition and in conformity with this section.

(2) The fuel system shall be free of any leaks.

(3) The fuel tank shall be closed with a fitted metal or plastic cap and shall be rigidly attached to the vehicle.

(4) No fuel tank may be located in the passenger compartment of a motor vehicle unless it was installed by a motor vehicle manufacturer licensed under s. 218.01, Stats., or is a replacement of such a tank.

(5) No fuel tank may be located in an engine compartment, trunk, underneath a vehicle or in the bed of a truck except the following:

(a) A fuel tank installed by a motor vehicle manufacturer licensed under s. 218.01, Stats., or a replacement for such a tank.

(b) An auxiliary fuel tank.

(c) An alternate fuel tank.

(6) Replacement, auxiliary and alternate fuel tanks may be installed by the owner of the vehicle or by a person in the business of fuel system installation. All fuel tanks shall meet or exceed industry standards for commercially manufactured fuel tanks which are certified for use in the type of vehicle in which the fuel tank is installed and for use with the type of fuel the tank is intended to contain.

TRANS 305.25 HORN. (1) The horn of every motor vehicle shall be maintained in proper working condition and in conformity with this section and s. 347.38, Stats.

(2) The horn wiring and connections shall be maintained in good condition.

(3) The horn shall be securely fastened to the vehicle.

(4) Every motor vehicle shall be equipped with a bar, button, ring or other actuation device for making electrical connection. The device shall be easily reached from the driver's seat while the driver is secured by a safety belt. A hand-activated horn utilizing an air bulb does not meet the requirements of this section.

TRANS 305.26 MIRRORS. (1) All motor vehicles originally manufactured with an inside mounted rearview mirror and all homemade and reconstructed motor vehicles registered after January 1, 1975, shall be equipped with an inside mounted rearview mirror. All motor vehicles originally manufactured with a left outside rearview mirror and all homemade and reconstructed motor vehicles registered after January 1, 1975, shall be equipped with a left outside rearview mirror.

(2) The mirrors of every motor vehicle shall be maintained in proper working condition and in conformity with this section and s. 347.40, Stats.

(3) No mirror may be broken, cracked, discolored, non-reflective or otherwise reflect an inadequate image. All mirrors shall be securely mounted on the vehicle.

(4) If the vehicle is constructed, loaded, or towing another vehicle so as to prevent the operator's clear view to the right rear, adequate additional mirrors shall be installed on both sides of the outside of the vehicle.

TRANS 305.27 RESTRAINING DEVICES AND SEATS. (1) All automobiles manufactured on or after January 1, 1972, shall have safety belts installed at all designated seating positions which meet the specifications of the safety belt system with which the vehicle was originally manufactured. All light trucks and motor homes manufactured after January 1, 1976, shall have safety belts installed at all designated seating positions which meet the specifications of the safety belt system with which the vehicle was originally manufactured. All homemade and reconstructed motor vehicles registered on or after January 1, 1975, shall have safety belts installed at all designated seating positions.

(2) All automobiles manufactured after January 1, 1969, and all light trucks and motor homes manufactured after September 1, 1991, shall be equipped with head restraints meeting the specifications of the head restraints with which the vehicle was originally manufactured. All homemade and reconstructed vehicles registered after January 1, 1975, shall be equipped with head restraints for the left and right front seating positions which meet the specifications of head restraints installed in vehicles manufactured in the year in which the homemade or reconstructed vehicle is first registered.

(3) The restraining devices, including air bags, of every motor vehicle shall be maintained in proper working condition and in conformity with this section and s. 347.48, Stats. All required and optional restraining devices, including air bags, shall remain installed or be replaced by like equipment.

(4) All safety belts shall be free of excessive fraying and be securely mounted to the motor vehicle.

(5) The seat and seat mechanisms of every motor vehicle shall be in proper working condition. All seats shall be securely fastened to the motor vehicle.

TRANS 305.28 SPEED INDICATOR AND ODOMETER. (1) The speed indicator of every motor vehicle primarily designed for use upon a highway shall be maintained in proper working condition within ± 4 percent accuracy at all speeds between 40 miles per hour and 65 miles per hour and in conformity with this section and s. 347.41, Stats.

(2) All speed indicators shall be equipped with a lamp that clearly illuminates the speed indicator when the vehicle's headlights or parking lamps are actuated.

(3) Every motor vehicle subject to registration under ch. 341, Stats., shall be equipped with a mileage odometer that registers the miles accumulated within ± 4 percent accuracy. The odometer shall be maintained in proper working condition.

(4) Every speed indicator and odometer shall be so mounted and positioned as to be clearly visible to the driver at all times.

TRANS 305.29 STEERING AND SUSPENSION. (1) The steering and suspension of every motor vehicle shall be maintained in proper working condition and in conformity with this section and s. 347.455, Stats.

(2) The steering linkage shall not be worn, jammed or bind, nor shall the steering system have excessive lash. Lash of more than $1/8$ of one complete turn of the steering wheel is excessive.

(3) The belts assisting the power steering unit shall be in proper working condition and may not be missing, loose, or excessively frayed or cracked.

(4) The power steering unit shall be in proper working condition. No portion of a power steering unit or steering linkage may be disconnected. The power steering unit shall contain the proper fluid levels. All hoses and connections shall be in proper working condition and will have no leaks or visible cuts or cracks.

(5)(a) Every motor vehicle shall be equipped with a steering wheel the same size as the one with which the vehicle was manufactured or a replacement not less than 13 inches in diameter. Every homemade and reconstructed vehicle registered after January 1, 1975, shall have a steering wheel of not less than 13 inches in diameter.

(b) All steering wheels shall be in proper working condition. The steering wheel shall be secured to the steering shaft by a locking device which prevents accidental removal. All steering wheels will be positioned to be operated with the driver seated in the front seat.

(6) All springs, shackles and cross stabilization linkage, including torsion bars, shall be in proper adjustment and shall not be loose, disconnected or broken.

(7)(a) Every motor vehicle originally manufactured with shock absorbing devices and every homemade and reconstructed vehicles registered on or after January 1, 1975, shall have shock absorbing devices which function at suspension points.

(b) All shock absorbing devices shall be in proper and effective working condition, free of leaks, and securely attached to the unit mountings. The mountings and housings shall not be loose or weakened. Shock absorbing devices are ineffective when the vehicle continues a free rocking motion for more than 2 cycles. The inspection procedure for shock absorbing devices is as follows: With the vehicle on a level surface, push down on one corner of the vehicle and release. Note the number of cycles of free rocking motion. Repeat the procedure at the other corners of the vehicle.

(8) Extended shackles in excess of 2 inches beyond original manufacturer's specifications is an unsafe modification and may not be used. Extended shackles up to 2 inches shall provide the same level of support and stability as provided by original equipment.

(9) No vehicle may be operated noticeably out of alignment.

TRANS 305.30 TIRES AND RIMS. (1) The tires and rims on every vehicle shall be maintained in proper condition and in conformity with this section and s. 347.45, Stats.

(2) Every tire shall have no less than 2/32 tread depth in all major tire grooves measured at 2 points no less than 15 inches apart.

(3) The tires on any vehicle required to have fenders shall not protrude more than 2 inches beyond the fender line at the highest point of the tire. The measurement shall be from the original fender line of the vehicle as equipped by the original manufacturer.

(4) Weight imposed on the tires or rims may not exceed that weight which is specified by the manufacturer of the tires or rims.

(5) No vehicle may have tires of different size or construction on the same axle, or directly across from each other on vehicles without a common axle, except that this subsection does not prohibit the use of mini spare tires temporarily used in accordance with manufacturer's specifications or other spare tires and rims that are temporarily used.

EXAMPLE: Mounting a radial tire on the left front side and a bias ply tire on the right front side of an automobile is prohibited.

(6) No tire shall be repaired using a method not recommended by the manufacturer and there may not be tread or sidewall cuts or snags in excess of one inch in any direction as measured on the tire, deep enough to expose or damage the body cords,

nor may there be any bump, bulge, knot, sidewall separation or failure or partial failure of the tire structure.

(7) No tire may be used that has been stamped or marked in such a manner so as to indicate that such tire is not to be operated on a highway.

(8) The rims may not be damaged, dented, bent or otherwise distorted, rusted or corroded.

(9) No rim may have loose or missing nuts, lugs or bolts.

TRANS 305.31 MODIFICATIONS AFFECTING HEIGHT OF A VEHICLE.

(1) Modifications authorized by s. 347.455, Stats., may not cause the front or rear bumper height of any vehicle to be altered more than the distance allowed by s. 347.455, Stats., from the original height of the bumper as specified by the vehicle manufacturer. Four wheel drive vehicles and motor trucks with a gross weight of not more than 8,000 pounds may not be modified so as to cause the vehicles to ride more than a total of 9 inches above the height of the vehicles specified by the manufacturer combining alterations under s. 347.455(2), Stats., and changes in tire size under s. 347.455(3), Stats. In the absence of manufacturer's specifications, every bumper shall meet the height standards established by s. Trans 305.18(2)(a).

(2) Changes in the height of a vehicle shall be measured from the level surface on which the vehicle stands to any part of the vehicle. When measuring to a part of the vehicle body, consideration shall be given to specific modifications allowed by s. Trans 305.21(3) in addition to alterations allowed by s. 347.455, Stats.

(3) The manufacturer's specified height of any part of a vehicle may be determined from the data published by the manufacturer or other manufacturer publications, such as the owner's manual, or by comparison with a similar model vehicle as normally delivered by the manufacturer.

(4) No person may operate any vehicle which has a fixed part of the vehicle located in a position that would contact the road surface before the wheel rim in the event of tire failure.

Trans 305.32 VENT, SIDE AND REAR WINDOWS. (1) All glass used in vent, side or rear windows shall be safety glass and shall be plainly marked to identify it as safety glass, or a certification from the glass supplier stating that the glass is approved safety glass shall be carried in the vehicle during operation or vehicle inspection, or both. All glazing in the vent, side or rear windows shall be free of sharp edges severe enough to cause injury, cracks, etching, damage or other conditions which distort or interfere with vision.

(2) All front side windows in the driver's compartment which need to open for the making of arm signals shall operate so as to permit the making of arm signals.

(3) The vent and front side windows may not have cloudiness or etching in excess of 2 inches from any edge. The rear window may not have cloudiness or etching in excess of 2 inches from any edge unless the vehicle is equipped with an outside rearview mirror on the left and right side of the driver's compartment.

(4)(a) The vent and front side windows may not have any sign, poster or other nontransparent material upon them, other than a certificate or sticker issued by order of a governmental agency.

(b) Tinting of the vent and front side windows is permitted as follows:

1. The windows are tinted by the manufacturer of the glazing and are installed as part of the original manufacturing process.

2. The windows are tinted by the application of tinting film to the inside of the glazing provided that the combination of the glazing and tinting film permits passage

through the windows of at least 50 percent of the visible light striking the windows. Tinting films permitted under this subdivision may not be reflective.

3. The windows are tinted, upon the recommendation of a physician or a Christian Science practitioner treating the owner, or an immediate family member of the owner of the vehicle, by the application of tinting film to the inside of the glazing provided that the combination of the glazing and tinting film permits passage through the windows of at least 35 percent of the visible light striking the windows. Tinting films permitted under this subdivision may not be reflective. A written statement from the treating physician or Christian Science practitioner which identifies the patient, the medical condition justifying the recommendation, whether the condition is temporary or permanent and the vehicle to which the recommendation applies, including the make, model, year and vehicle identification number, shall be carried in the vehicle at all times. Tinting film applied under this subparagraph shall be removed when a vehicle covered by the recommendation is sold, when the person for whom a recommendation was made no longer resides in the household of the owner of the vehicle or when the duration of a temporary condition which is the basis for a recommendation has expired.

(5)(a) The rear window may not have any sign, poster or other nontransparent material upon it, other than a certificate or sticker issued by order of a governmental agency.

(b) Tinting of the rear window is permitted as follows:

1. The window is tinted by the manufacturer of the glazing and is installed as part of the original manufacturing process.

2. The window is tinted by the application of tinting film to the inside of the glazing provided that the combination of the glazing and tinting film permits passage

through the window of at least 35 percent of the visible light striking the window. The tinting films permitted under this subdivision may not be reflective.

3. If a rear window does not transmit at least 60 percent of the visible light striking the window, the vehicle shall be equipped with an outside rearview mirror on the left and right side of the driver's compartment.

(6) Tinting of rear side windows is permitted as follows:

1. The windows are tinted by the manufacturer of the glazing and are installed as part of the original manufacturing process.

2. The windows are tinted by the application of tinting film to the inside of the glazing provided that the combination of the glazing and tinting film permits passage through the windows of at least 35 percent of the visible light striking the window. The tinting films permitted under this subdivision may not be reflective.

(7) When measuring total light transmittance under subs. (4)(b), 5(b) and (6), law enforcement officers shall allow a tolerance of 3 percent.

TRANS 305.33 WINDSHIELD DEFROSTER-DEFOGGER. (1) Every motor vehicle originally equipped with a windshield defroster-defogger and every motor vehicle manufactured after January 1, 1955, shall be equipped with a defroster-defogger system. Any motor vehicle lawfully manufactured and operated without a roof, doors or side windows is exempt from the requirements of this section.

(2) The defroster-defogger system shall be capable of removing condensation and frost from the windshield.

TRANS 305.34 WINDSHIELDS. (1) Every motor vehicle manufactured after January 1, 1936, shall have a windshield made of safety glass. Such glass shall be plainly marked to identify it as safety glass or a certification from the glass supplier

stating that the glass is approved safety glass shall be carried in the vehicle during operation or vehicle inspection, or both.

(2) The windshield shall be of sufficient size to provide adequate protection for the driver and shall be in place when operating on a highway.

(3) The windshield may not be excessively cracked or damaged. A windshield is excessively cracked or damaged if:

(a) The windshield has a crack inside, or which extends inside, the windshield critical area.

(b) The windshield has cracks which extend into any area more than 8 inches from the frame.

(c) The windshield has stone or shot damage with a diameter in excess of $\frac{1}{2}$ inch in the windshield critical area or in excess of $1\frac{1}{2}$ inches in diameter in any other area.

(4) The windshield may not have etching, scratches, abrasion or repairs of any type which impair or distort vision within the windshield critical area.

(5) The windshield may not have cloudiness or etching in excess of one inch around the outside edge on the driver's side or in excess of 2 inches on the passenger's side.

(6) Nothing may be placed or suspended in or on the vehicle or windshield so as to obstruct the driver's clear vision through the windshield. There may not be any posters, stickers or other nontransparent material, other than a certificate or sticker issued by order of a governmental agency, located on the windshield or located between the driver and the windshield. This subsection does not prohibit the following:

(a) Attachment of an inside rearview mirror in accordance with s. Trans 305.26.

(b) Windshields tinted by the manufacturer of the glazing and installed as part of the original manufacturing process.

(c) Application of window tinting film or other nontransparent material to the inside of the windshield if it is attached only to that portion of the windshield which is both outside the critical area and above the horizontal line delineated by the mark "A" or "A." If no such mark was affixed to the windshield by its manufacturer, no window tinting film may be attached to the windshield.

TRANS 305.35 WINDSHIELD WIPERS. (1) All motor vehicles originally equipped with 2 wiper arms and 2 wiper blades, one set on the driver's side and one set on the passenger side, shall have both in place. Every motor vehicle manufactured after January 1, 1950, and every homemade or reconstructed vehicle registered after January 1, 1975, shall have a system of windshield wipers capable of clearing the windshield critical area.

(2)(a) The windshield wiper system of every motor vehicle shall be maintained in good working condition and in conformity with this section.

(b) The windshield wiper switch, wiring and connections shall be in proper working condition.

(c) Every windshield wiper blade shall be in good condition so as to adequately clear the windshield.

(3) Every windshield wiper shall be as large as practicable to adequately clear the windshield. If the windshield wiper system was originally equipped with multi-speed capability, the windshield wipers shall operate on at least 2 separate, constant speeds, one of which is at least 20 cycles per minute and the other which is at least 15 cycles

per minute faster. Windshield wipers shall operate by use of an electric, hydraulic or vacuum device.

(4) Every motor vehicle manufactured after January 1, 1968, shall be equipped with a windshield washer system that is maintained in proper operating condition with adequate fluid available when the mechanism is activated.

SUBCHAPTER III

MOTORCYCLES

TRANS 305.37 APPLICABILITY OF SUBCHAPTER II. (1) The following sections of subch. II apply to all motorcycles:

(a) Trans 305.17, brakes, except as otherwise provided in s. Trans 305.38.

(b) Trans 305.23, frames.

(c) Trans 305.28, speed indicator and odometer.

(d) Trans 305.30, tires, wheels and rims.

(2) Section Trans 305.35 applies to type 2 motorcycles.

TRANS 305.38 BRAKES. (1) The brake system on every motorcycle shall meet the requirements of ss. 347.35(2) and 347.36, Stats., and s. Trans 305.17, except that:

(a) Braking is required on only one wheel of a 2-wheel motorcycle unless the motorcycle was originally manufactured after [Revisor...insert effective date of this chapter] with a braking system on both wheels, in which case brakes are required on both wheels.

(b) A parking brake is not required on a type 1 motorcycle.

TRANS 305.39 EXHAUST SYSTEM. (1) Every motorcycle shall be equipped with a functioning exhaust system that is maintained in proper working condition so as

to reduce engine noise. The exhaust system shall be maintained in conformity with this section and s. 347.39, Stats.

(2) Every exhaust system shall be maintained free of leaks from the engine exhaust ports through the piping and muffler to the end of the exhaust system. A protective shield or insulated section shall be provided for any portion of the exhaust system that extends above and to the rear of the foot pegs or rests.

TRANS 305.40 FENDERS AND BUMPERS. (1) A fender over each rear wheel is required on every motorcycle except those originally manufactured without a rear fender. A front fender is required on every motorcycle manufactured after [Revisor: The effective date of this section]. The fender shall cover the complete tread width area of the tire and lengthwise from 15 degrees to the front and 60 degrees to the rear when measured at the center of the axle to the top of the tire on a vertical plane.

(2) Every type 2 motorcycle shall be equipped with a rear bumper which meets the requirements for a homemade or reconstructed vehicle under s. Trans 305.18.

TRANS 305.41 FUEL SYSTEM. (1) The fuel system on every motorcycle shall be free of leaks.

(2) Every fuel tank shall have a cap or positive closing device.

(3) No fuel tank may be used for operation of the motorcycle except one produced by a manufacturer of fuel tanks for motorcycles or one that meets or exceeds industry standards for commercially manufactured tanks.

TRANS 305.42 HORN. (1) Every motorcycle shall be equipped with a horn which is securely attached to the cycle and is in conformity with this section and s. 347.38, Stats.

(2) The horn shall be activated by use of a button to make the electrical connection and shall be maintained in proper working condition.

TRANS 305.43 LIGHTING. (1) Every motorcycle shall be equipped with all lighting devices required by ch. 347, Stats. In addition, every motorcycle manufactured after January 1, 1972, shall be equipped with 2 amber direction signal lamps on the front and 2 direction signal lamps on the rear which may be red or amber.

(2) A motorcycle may be equipped with no more than 2 auxiliary lamps, including auxiliary lamps on a side car.

(3) Motorcycles and attached sidecars may be equipped with marker lamps provided that:

(a) No marker lamp exceeds a wattage of 10 watts.

(b) No marker lamp interferes with the visibility of a headlamp, tail lamp, stop lamp or direction signal.

(c) No lamp shows a color except red to the rear and amber to the front.

(4) All lighting devices shall be maintained in proper working condition and in conformity with ch. 347, Stats. All wiring and connections shall be maintained in good condition and there shall be no cracked, broken or missing lenses or reflectors.

TRANS 305.44 MIRRORS. Every motorcycle shall be equipped with at least one mirror meeting the requirements of s. 347.40, Stats., and s. Trans 305.26.

TRANS 305.45 SIDECARS. (1) A type 1 motorcycle may be equipped with one sidecar securely attached to the frame of the motorcycle. A sidecar may only be attached to the right side of the motorcycle.

(2) A tail lamp and stop lamp or a combination lamp performing both functions meeting the requirements of ss. 347.13(1) and 374.14(2), Stats., shall be mounted on

the rear of any side car. A sidecar may be equipped with a headlamp if the headlamp is mounted as required by s. 347.09(2), Stats.

TRANS 305.46 SUSPENSION SYSTEM. (1) Any motorcycle with a front suspension system modified before January 1, 1976, may have a rake of no more than 55 degrees, provided the trail is at least 2 inches.

(2) Any motorcycle, commencing with the 1976 models, may be modified to cause the front suspension system to have a rake of no more than 50 degrees, provided the trail is at least 2 inches.

(3) As used in this section:

(a) "Rake" means the angle formed by the front suspension, or "forks," and a vertical line drawn from the top of the front "forks" perpendicular to the ground.

(b) "Trail" means the distance from a point on the roadway directly underneath the center of the front wheel to the projected point where an extension of the front frame through the fork head would intersect the roadway.

(4) Every motorcycle shall be equipped with a shock absorbing front suspension system.

(a) The main tubes or the individual sliding tubes on a telescoping front suspension system shall be of one piece construction. Screw-on extensions, or "slugs," are prohibited.

(b) All shock absorbing units shall be in proper working condition and free of leaks.

Figure 1
"Rake" and "Trail" Illustrated

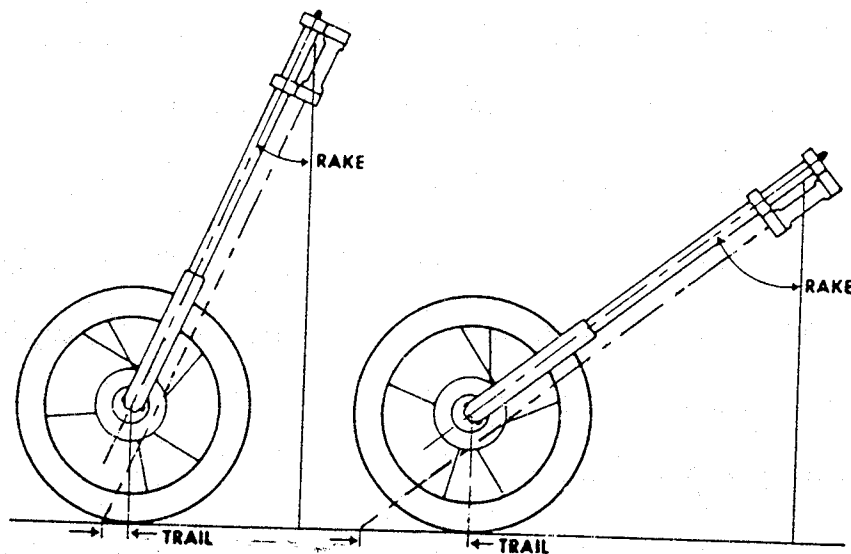

Figure 1

TRANS 305.47 TIRES, WHEELS AND RIMS. (1) The tires of every motorcycle and of any attached sidecar or trailer shall meet the requirements of s. Trans 305.30.

SUBCHAPTER IV

HEAVY TRUCKS, TRAILERS AND SEMI-TRAILERS

TRANS 305.48 DEFINITIONS. For purposes of this subchapter, "vehicle" means heavy trucks, trailers and semitrailers.

TRANS 305.485 APPLICABILITY OF SUBCHAPTER II. (1) The following sections of subch. II apply to heavy trucks, trailers and semitrailers:

- (a) Trans 305.22, fenders and projecting parts.
- (b) Trans 305.30, tires, wheels and rims.

(2) The following sections of subch. II apply to heavy trucks:

- (a) Trans 305.07, auxiliary lamps.
- (b) The provisions of s. Trans 305.28 concerning odometers.
- (c) Trans 305.32, vent, side and rear windows.
- (d) Trans 305.34, windshields.
- (e) Trans 305.35, windshield wipers.

TRANS 305.49 AXLE CONTROL VALVES. (1) When a vehicle is equipped with an axle or axles that raises or lowers by means of air pressure, spring force or hydraulic pressure, the control valves shall be installed as follows:

(a) The control valve that regulates the amount of pressure shall be mounted outside of the driver's compartment.

(b) The control valve that regulates the movement of the axle or axles so as to raise or lower the axle or axles may be in the driver's compartment.

(2) This section applies to vehicles first registered in this state or manufactured on or after [Revisor: insert effective date of this chapter].

TRANS 305.50 BED AND BODY ON TRAILERS AND SEMITRAILERS. The bed or body of a trailer or semitrailer shall not contain holes, cracks or other openings which would allow the vehicle contents to drop, leak or spill upon the highway.

TRANS 305.51 BRAKES ON TRAILERS AND SEMITRAILERS. (1) The brake system on every trailer or semi-trailer required by s. 347.35(3), Stats., to have brakes shall be maintained in proper working condition and in conformity with this section.

(2) Every semi-trailer and trailer over 10,000 pounds gross weight and required to have brakes shall have braking ability on every wheel, except as exempted by s. Trans 327.03(4) or other applicable law.

(3) No person may operate any trailer or semi-trailer upon a highway if:

- (a) The vehicle stops with obvious side pull when brakes are applied;
- (b) The brake lining, pads, drums or rotors on any wheel are worn below the manufacturer's recommended minimum operating level;
- (c) Any part of the brake system is missing, broken or disconnected;
- (d) The cables are frayed or hoses are abraded, damaged, deteriorated or leaking;

or

(e) There is visual evidence of leakage of grease, oil or brake fluid that may have contaminated the braking surface.

(4) This section does not apply to any trailer or semi-trailer when its actual gross weight is less than 3,000 pounds, or to farm trailers.

NOTE: Ch. Trans 308 establishes requirements as to the design, type and performance standards of brakes required by s. 347.35(3) on trailers and semitrailers. Section 347.36, Stats., also establishes minimum performance standards for brakes on combinations of vehicles.

TRANS 305.52 COUPLING DEVICES. (1) When 2 or more vehicles are operated in combination, the coupling devices connecting the vehicles shall be designed, constructed and installed and the vehicles shall be designed and constructed, so that when the combination is operated in a straight line on a level, smooth, paved surface, the path of the towed vehicle will not deviate more than 3 inches to either side of the path of the vehicle that tows it.

(2) Coupling devices and safety devices shall meet the requirements of s. 347.47, Stats.

NOTE: Ch. Trans 308 establishes requirements as to the type, design and strength of couplings, safety chains, leveling bars and cables required by s. 347.47, Stats., on trailers, semitrailers and mobile homes.

(3) When used as part of a fifth wheel assembly on a truck tractor, the king pin shall fit snugly into the upper and lower halves, but shall not bind.

TRANS 305.53 FENDERS AND MUD GUARDS. Every trailer or semi-trailer shall be equipped with adequate fenders to cover the tires, except when the construction of the trailer or semitrailer is such that the body, bed, load, or load-carrying area covers the tires. Semitrailers operated in intercity movement and not equipped with dump bodies shall have sufficient mud guards as specified in s. 347.46(2), Stats., unless exempted under s. 347.46(2)(c), Stats.

TRANS 305.54 FRAMES ON HEAVY TRUCKS, TRAILERS AND SEMI-TRAILERS. (1) No frame may be repaired, modified or altered, nor may additional support be added to a frame, if the structural integrity or alignment of the vehicle is adversely affected.

(2) No frame may be rusted, damaged or cracked to the extent that it no longer properly supports the vehicle or the load carried on the vehicle.

(3) No vehicle may be operated on a highway which is noticeably out of alignment.

TRANS 305.55 LIGHTING DEVICES. (1) Every vehicle shall be equipped with all lamps and reflectors required by ch. 347, Stats., and this section. Required lamps shall be capable of being operated at all times.

(2) Every vehicle shall be equipped with clearance lamps, sidemarker lamps and reflectors as follows:

(a) Truck tractors and road tractors shall be equipped with 2 clearance lamps on the front of the vehicle and with an amber side marker lamp on each side of the vehicle as far to the front as practicable.

(b) Motor trucks, trailers and semitrailers whose overall width is more than 80 inches shall be equipped with 2 clearance lamps on the front and 2 clearance lamps on

the rear of the vehicle; 2 reflectors on the rear of the vehicle; and on each side of the vehicle, 2 side marker lamps mounted so as to identify as nearly as possible the extreme length of the vehicle.

(c) Motor trucks, trailers and semitrailers whose overall width is 80 inches or less shall be equipped with 2 reflectors on the rear of the vehicle and on each side of the vehicle, 2 side marker lamps mounted so as to identify as nearly as possible the extreme length of the vehicle.

(d) Clearance lamps, sidemarker lamps and reflectors shall conform to the color, mounting and visibility requirements specified in ss. 347.17, 347.18 and 347.19, Stats.

(3) Three identification lamps shall be mounted horizontally at the vertical center line on the front and rear of every motor truck which is 80 or more inches in overall width, on the front of every truck tractor or road tractor which is 80 or more inches in overall width, and on the rear of every trailer or semitrailer which is 80 or more inches in overall width. A truck tractor or road tractor need not be equipped with rear identification lamps. The lamps shall be mounted as close as practicable to the top of the vehicle and at the same height. The color of front identification lamps shall be amber and the color of rear identification lamps shall be red.

(4) All lamps shall be permanently and securely mounted on a permanent part of the vehicle, except that temporary lamps mounted on projecting loads need not be permanently mounted.

(5) Reflectorized material extending across the full width of the vehicle which meets the mounting and visibility specifications of ss. 347.18 and 347.19, Stats., may be used in lieu of the reflectors required by s. 347.16, Stats.

TRANS 305.56 REAR END PROTECTION. (1) Every vehicle, except truck tractors, pole trailers and vehicles engaged in automobile haulaway operations, manufactured after December 31, 1952 which is so constructed that the body or the chassis assembly, if without a body, has a clearance at the rear end of more than 30 inches from the ground when empty, shall be provided with bumpers or devices serving similar purposes which shall be so constructed and located that:

(a) The clearance between the effective bottom of the bumpers or devices and the ground may not exceed 30 inches with the vehicle empty.

(b) The maximum distance between bumpers, or devices, if more than one is used, may not exceed 24 inches.

(c) The maximum transverse distance from the widest part of the vehicle at the rear to the bumper or device may not exceed 18 inches.

(d) The bumper or device shall be located not more than 24 inches forward of the extreme rear of the vehicle.

(2) Bumpers or other protective devices shall be substantially constructed and firmly attached. No vehicle may be operated with missing, broken or weakened parts so as to render any required protective device ineffective.

(3) Motor trucks, truck tractors and road tractors constructed and maintained so that the body, chassis or other parts of the motor vehicle provide the rear end protection required by this section shall be deemed to be in compliance with this section.

TRANS 305.57 SUSPENSION SYSTEM ON TRAILERS AND SEMITRAILERS.

(1) All parts of the suspension system of a trailer or semitrailer, including the springs, shackles, shock absorbers and cross stabilization linkage, including torsion bars, air lines, air valves, air bags and all attachment parts, shall be in proper adjustment.

(2) No trailer or semitrailer may have any loose, disconnected, leaking or broken suspension parts.

(3) The suspension system of a trailer or semitrailer may not cause the vehicle to track noticeably out of alignment with the towing unit.

TRANS 305.58 WIRING. (1) Wiring for both low tension and high tension circuits shall be constructed and installed so as to function reliably and adequately.

(2) Required lamps shall be connected to the power source with stranded wire.

(3) Wiring shall, when possible, be grouped together and protected by tape, braid, sheath, tube or other covering capable of withstanding surface abrasion.

(4) Wiring shall be properly supported.

(5) Wiring may not be located where it is likely to be charred, overheated or enmeshed in moving parts.

(6) The edges of all holes in metal through which the wiring passes, unless the wiring is metal covered, shall be rolled or bushed with a grommet of rubber or other suitable material.

SECTION 3. Trans 149.03(4)(a)2 is amended to read:

Trans 149.03(4)(a)2 Training in the safety inspection of a vehicle for compliance with the requirements of ch. ~~MVD-5~~ Trans 305 and ch. 347, Stats.

SECTION 4. Trans 149.04(3)(b) is amended to read:

Trans 149.04(3)(b) The inspector passes a vehicle for inspection that contains stolen parts or parts of a stolen vehicle, or that does not meet the equipment safety requirements of ch. ~~MVD-5~~ Trans 305 or ch. 347, Stats.

SECTION 5. Trans 149.06(4)(a) is amended to read:

Trans 149.06(4)(a) The vehicle is not in compliance with the equipment provisions of ch. 347, Stats., ch. ~~MVD-5~~ Trans 305, or federal motor vehicle safety standards established under the national traffic and motor vehicle safety act, 15 USC s. 1381, et seq., or the regulations promulgated thereunder in 49 CFR part 571. Noncompliance includes, but is not limited to, any device or element of a vehicle required by the above regulations being rendered inoperative or defective, or being removed from the vehicle;

(END OF RULE TEXT)

Effective Date. This rule shall take effect on the first day of the month following publication in the Wisconsin Administrative Register as provided in s. 227.22(2), Stats.

Signed at Madison, Wisconsin, this 19 day
of December, 1995.

Jerome D. Mulvihy Deputy Sec
~~for~~ CHARLES H. THOMPSON
Secretary
Wisconsin Department of Transportation



Wisconsin Department of Transportation

Tommy G. Thompson
Governor

Charles H. Thompson
Secretary

OFFICE OF GENERAL COUNSEL
P. O. Box 7910
Madison, WI 53707-7910

December 20, 1995

Mr. Gary Poulson
Deputy Revisor of Statutes
131 West Wilson Street, Suite 800
Madison, Wisconsin 53703

RE: **CLEARINGHOUSE RULE 91-98**

In the Matter of the Adoption of **TRANS 305**, Wisconsin Administrative Code,
relating to **motor vehicle equipment standards**.

Dear Mr. Poulson:

Enclosed for filing, pursuant to s. 227.20, Wis. Stats., is a certified copy of **CR 91-98**, an administrative rule relating to the above-mentioned matter. This rule is submitted by the Wisconsin Department of Transportation.

Sincerely,

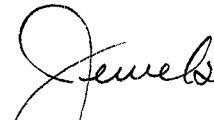
Julie A. Johnson
Paralegal

Enclosures

cc: Ann Agnew
Dorothy Kapke
Jim McDonnell
Bill Singletary
Roger Cross
Michael Moore
Terry Bengtson
Lyle Walheim
Steve Gasper
Karen Baker

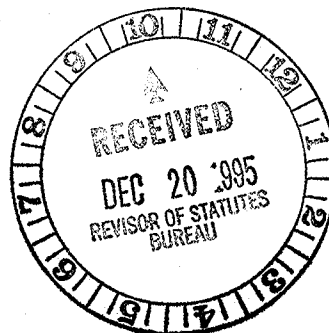

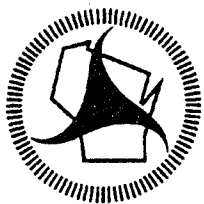

Wisconsin Department of Transportation

Tommy G. Thompson
Governor

Charles H. Thompson
Secretary

OFFICE OF GENERAL COUNSEL
P. O. Box 7910
Madison, WI 53707-7910

November 28, 1995

The Honorable Senator Alan J. Lasee
Chairman, Senate Transportation Committee
Room 6 South, State Capitol
Madison, Wisconsin 53702

The Honorable Representative David Brandemuehl
Chairman, Assembly Committee on Highways & Transportation
Room 317 North, State Capitol
Madison, Wisconsin 53702

**RE: Proposed Administrative Rule
Chapter Trans 305, Wisconsin Administrative Code
Clearinghouse Rule No. 91-98**

Gentlemen:

The Wisconsin Department of Transportation is submitting on its own initiative a germane amendment to Clearinghouse Rule 91-98, relating to standards for vehicle equipment. Upon further review, the Department has decided to amend language in ss. Trans 305.065(2)(b), 305.31(1) and 305.32(1).

Accordingly, pursuant to §227.19(4)(b)3, Stats., the Department hereby submits germane amendments to pages 13, 31 and 32 (attached). Please replace the originally submitted pages 13, 31 and 32 with the attached. A redlined version indicating the changes that were made is also attached. These germane amendments will not extend the committees' review period.

Thank you for your consideration of this proposal.

Sincerely,

Julie A. Johnson
Paralegal

cc: Senator Robert Welch
Representative Glenn Grothman
Gary Poulson
Bill Singletary
Roger Cross
Michael Moore
Terry Bengtson
Lyle Walheim
Steve Gasper
Karen Baker

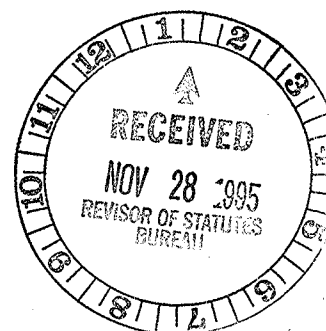

(b) Replica and street modified vehicles. The department shall issue a title indicating that a vehicle is a replica or street modified vehicle and the make and model year shown on the title shall be the original make and model year of the street modified vehicle or the make and model year of the vehicle being replicated. The installation of reproduction body parts on a previously manufactured and titled vehicle body and frame shall not be considered by the department to constitute a replica vehicle for purposes of identifying the vehicle on its title. A vehicle shall be considered a replica or a street modified vehicle if it has been certified by the owner to be a replica or a street modified vehicle for purposes of registration under s. 341.268, Stats. A vehicle shall also be considered a street modified vehicle if the vehicle's engine has been replaced with one which required adaptation beyond ordinary replacement.

(3) REGISTRATION. As provided in s. 341.10(6), Stats., no vehicle originally designed and manufactured for off-highway use may be registered by the department unless it bears the label required by s. 114 of the national traffic and motor vehicle safety act of 1966, as amended. The label shall be affixed by the original manufacturer and shall certify that at the time of manufacture the vehicle met all applicable federal motor vehicle safety standards. Vehicles generally not eligible to be registered include, but are not limited to, mini-bikes, go-carts and all-terrain vehicles.

NOTE: Section 114 of the National Traffic and Motor Vehicle Safety Act of 1966, as amended, is codified as 15 U.S.C. s. 1403. 49 CFR Part 567 establishes standards for the location and contents of the required label.

SUBCHAPTER II AUTOMOBILES, MOTOR HOMES AND LIGHT TRUCKS

TRANS 305.07 DEFINITIONS. For purposes of this subchapter, "motor vehicle" means automobiles, motor homes and light trucks.

nor may there be any bump, bulge, knot, sidewall separation or failure or partial failure of the tire structure.

(7) No tire may be used that has been stamped or marked in such a manner so as to indicate that such tire is not to be operated on a highway.

(8) The rims may not be damaged, dented, bent or otherwise distorted, rusted or corroded.

(9) No rim may have loose or missing nuts, lugs or bolts.

TRANS 305.31 MODIFICATIONS AFFECTING HEIGHT OF A VEHICLE.

(1) Modifications authorized by s. 347.455, Stats., may not cause the front or rear bumper height of any vehicle to be altered more than the distance allowed by s. 347.455, Stats., from the original height of the bumper as specified by the vehicle manufacturer. Four wheel drive vehicles and motor trucks with a gross weight of not more than 8,000 pounds may not be modified so as to cause the vehicles to ride more than a total of 9 inches above the height of the vehicles specified by the manufacturer combining alterations under s. 347.455(2), Stats., and changes in tire size under s. 347.455(3), Stats. In the absence of manufacturer's specifications, every bumper shall meet the height standards established by s. Trans 305.18(2)(a).

(2) Changes in the height of a vehicle shall be measured from the level surface on which the vehicle stands to any part of the vehicle. When measuring to a part of the vehicle body, consideration shall be given to specific modifications allowed by s. Trans 305.21(3) in addition to alterations allowed by s. 347.455, Stats.

(3) The manufacturer's specified height of any part of a vehicle may be determined from the data published by the manufacturer or other manufacturer publications, such as the owner's manual, or by comparison with a similar model vehicle as normally delivered by the manufacturer.

(4) No person may operate any vehicle which has a fixed part of the vehicle located in a position that would contact the road surface before the wheel rim in the event of tire failure.

Trans 305.32 VENT, SIDE AND REAR WINDOWS. (1) All glass used in vent, side or rear windows shall be safety glass and shall be plainly marked to identify it as safety glass, or a certification from the glass supplier stating that the glass is approved safety glass shall be carried in the vehicle during operation or vehicle inspection, or both. All glazing in the vent, side or rear windows shall be free of sharp edges severe enough to cause injury, cracks, etching, damage or other conditions which distort or interfere with vision.

(2) All front side windows in the driver's compartment which need to open for the making of arm signals shall operate so as to permit the making of arm signals.

(3) The vent and front side windows may not have cloudiness or etching in excess of 2 inches from any edge. The rear window may not have cloudiness or etching in excess of 2 inches from any edge unless the vehicle is equipped with an outside rearview mirror on the left and right side of the driver's compartment.

(4)(a) The vent and front side windows may not have any sign, poster or other nontransparent material upon them, other than a certificate or sticker issued by order of a governmental agency.

(b) Tinting of the vent and front side windows is permitted as follows:

1. The windows are tinted by the manufacturer of the glazing and are installed as part of the original manufacturing process.

2. The windows are tinted by the application of tinting film to the inside of the glazing provided that the combination of the glazing and tinting film permits passage through the windows of at least 50 percent of the visible light striking the windows. Tinting films permitted under this subdivision may not be reflective.

(b) Replica and street modified vehicles. The department shall issue a title indicating that a vehicle is a replica or street modified vehicle and the make and model year shown on the title shall be the original make and model year of the street modified vehicle or the make and model year of the vehicle being replicated. The installation of reproduction body parts on a previously manufactured and titled vehicle body and frame shall not be considered by the department to constitute a replica vehicle for purposes of identifying the vehicle on its title. A vehicle shall be considered a replica or a street modified vehicle if it has been certified by the owner to be a replica or a street modified vehicle for the purpose purposes of registration under s. 341.268, Stats., or A vehicle shall also be considered a street modified vehicle if the vehicle's engine has been replaced with one of different make and which requiring required adaptation beyond ordinary replacement.

(3) REGISTRATION. As provided in s. 341.10(6), Stats., no vehicle originally designed and manufactured for off-highway use may be registered by the department unless it bears the label required by s. 114 of the national traffic and motor vehicle safety act of 1966, as amended. The label shall be affixed by the original manufacturer and shall certify that at the time of manufacture the vehicle met all applicable federal motor vehicle safety standards. Vehicles generally not eligible to be registered include, but are not limited to, mini-bikes, go-carts and all-terrain vehicles.

NOTE: Section 114 of the National Traffic and Motor Vehicle Safety Act of 1966, as amended, is codified as 15 U.S.C. s. 1403. 49 CFR Part 567 establishes standards for the location and contents of the required label.

SUBCHAPTER II AUTOMOBILES, MOTOR HOMES AND LIGHT TRUCKS

nor may there be any bump, bulge, knot, sidewall separation or failure or partial failure of the tire structure.

(7) No tire may be used that has been stamped or marked in such a manner so as to indicate that such tire is not to be operated on a highway.

(8) The rims may not be damaged, dented, bent or otherwise distorted, rusted or corroded.

(9) No rim may have loose or missing nuts, lugs or bolts.

TRANS 305.31 MODIFICATIONS AFFECTING HEIGHT OF A VEHICLE.

(1) Modifications authorized by s. 347.455, Stats., may not cause the front or rear bumper height of any vehicle to be altered more than the distance allowed by s. 347.455, Stats., from the original height of the bumper as specified by the vehicle manufacturer. Four wheel drive vehicles and motor trucks with a gross weight of not more than 8,000 pounds may not be altered ~~modified so as to cause the vehicles to ride~~ more than a total of 9 inches ~~above the height of the vehicles specified by the manufacturer~~ combining alterations of suspension ~~under s. 347.455(2), Stats.~~ and changes in tire size ~~under s. 347.455(3), Stats.~~ In the absence of manufacturer's specifications, every bumper shall meet the height standards established by s. Trans 305.18(2)(a).

(2) Changes in the height of a vehicle shall be measured from the level surface on which the vehicle stands to any part of the vehicle. When measuring to a part of the vehicle body, consideration shall be given to specific modifications allowed by s. Trans 305.21(3) in addition to alterations allowed by s. 347.455, Stats.

(3) The manufacturer's specified height of any part of a vehicle may be determined from the data published by the manufacturer or other manufacturer publications, such as the owner's manual, or by comparison with a similar model vehicle as normally delivered by the manufacturer.

(4) No person may operate any vehicle which has a fixed part of the vehicle located in a position that would contact the road surface before the wheel rim in the event of tire failure.

Trans 305.32 VENT, SIDE AND REAR WINDOWS. (1) All glass used in vent, side or rear windows shall be safety glass and shall ~~not have any sharp edges severe enough to cause injury~~ ~~be plainly marked to identify it as safety glass, or a certification from the glass supplier stating that the glass is approved safety glass shall be carried in the vehicle during operation or vehicle inspection, or both.~~ All glazing in the vent, side or rear windows shall be free of ~~sharp edges severe enough to cause injury,~~ cracks, etching, damage or other conditions which distort or interfere with vision.

(2) All front side windows in the driver's compartment which need to open for the making of arm signals shall operate so as to permit the making of arm signals.

(3) The vent and front side windows may not have cloudiness or etching in excess of 2 inches from any edge. The rear window may not have cloudiness or etching in excess of 2 inches from any edge unless the vehicle is equipped with an outside rearview mirror on the left and right side of the driver's compartment.

(4)(a) The vent and front side windows may not have any sign, poster or other nontransparent material upon them, other than a certificate or sticker issued by order of a governmental agency.

(b) Tinting of the vent and front side windows is permitted as follows:

1. The windows are tinted by the manufacturer of the glazing and are installed as part of the original manufacturing process.

2. The windows are tinted by the application of tinting film to the inside of the glazing provided that the combination of the glazing and tinting film permits passage through the windows of at least 50 percent of the visible light striking the windows. Tinting films permitted under this subdivision may not be reflective.



Wisconsin Department of Transportation

Tommy G. Thompson
Governor

Charles H. Thompson
Secretary

OFFICE OF GENERAL COUNSEL
P. O. Box 7910
Madison, WI 53707-7910

December 1, 1995

The Honorable Senator Alan J. Lasee
Chairman, Senate Transportation Committee
Room 6 South, State Capitol
Madison, Wisconsin 53702

The Honorable Representative David Brandemuehl
Chairman, Assembly Committee on Highways & Transportation
Room 317 North, State Capitol
Madison, Wisconsin 53702

**RE: Proposed Administrative Rule
Chapter Trans 305, Wisconsin Administrative Code
Clearinghouse Rule No. 91-98**

Gentlemen:

The Wisconsin Department of Transportation is submitting on its own initiative a second germane amendment to Clearinghouse Rule 91-98, relating to standards for vehicle equipment. Upon further review, the Department has decided to amend language in ss. Trans 305.02(4) and 305.20(7).

Accordingly, pursuant to §227.19(4)(b)3, Stats., the Department hereby submits germane amendments to pages 5 and 23 (attached). Please replace the originally submitted pages 5 and 23 with the attached. A redlined version indicating the changes that were made is also attached. These germane amendments will not extend the committees' review period.

Thank you for your consideration of this proposal.

Sincerely,

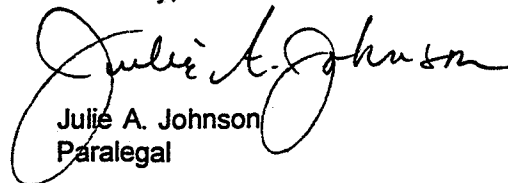
Julie A. Johnson
Paralegal

cc: Senator Robert Welch
Representative Glenn Grothman
Gary Poulson
Bill Singletary
Roger Cross
Michael Moore
Terry Bengtson
Lyle Walheim
Steve Gasper
Karen Baker

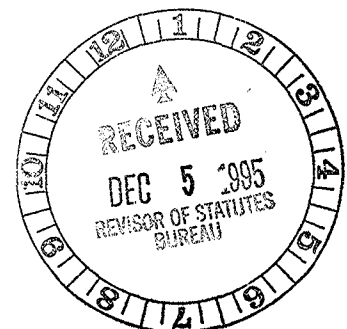

(c) Subchapter IV applies to heavy trucks, trailers and semi-trailers.

(3) Homemade or reconstructed vehicles registered in Wisconsin on or after January 1, 1975, shall meet the vehicle equipment standards in subchs. II, III and IV applicable to vehicles of the same type which are manufactured in the year in which the homemade or reconstructed vehicle is first registered in Wisconsin except as specifically provided. When subchs. II, III and IV make equipment standards applicable to vehicles manufactured after a certain date, the standards apply to homemade and reconstructed vehicles first registered in Wisconsin after that date.

(4) Vehicles covered under subchs. II, III and IV that are street modified or replica vehicles shall meet the following vehicle equipment requirements:

(a) The vehicle equipment requirements for a street modified vehicle shall be the same as the vehicle equipment requirements for a vehicle of the same type and model year that is not a street modified vehicle.

(b) The vehicle equipment requirements for a replica vehicle shall be the same as the vehicle equipment requirements for a vehicle of the same type and model year as the vehicle used for purposes of the reproduction.

(5) No section of this chapter requires vehicles meeting equipment requirements established by Wisconsin or federal law for the year of original manufacture to update vehicle equipment to meet increased requirements under this chapter unless updating is required by ch. 347, Stats., or sub. (3).

(6) Vehicles that were legally titled and registered in another jurisdiction and that met vehicle equipment standards established by the law of the other jurisdiction shall not

(5) The tail pipe shall extend to the outside body line of the vehicle, except that light trucks may have the exhaust outlet extend only to the rear of the vehicle cab if the cargo area is not enclosed and used for passenger transportation.

(6) The exhaust system shall not be modified so as to pass through the passenger compartment.

(7) All air pollution control equipment required by the federal clean air act and its implementing regulations shall remain installed or be replaced with identical or comparable tested parts. Air pollution control equipment originally installed by the manufacturer or identical or comparable tested replacement equipment may not be removed, disconnected or physically altered to be ineffective.

(8) All air pollution control equipment required under sub. (7) shall be maintained in proper working condition and in conformity with s. 144.42(6), Stats.

TRANS 305.21 FLOOR PAN AND FIREWALL. (1) The floor pan of every motor vehicle shall be maintained in good condition and in conformity with this section.

(2) The floor pan shall be free of rusted areas or holes which may allow entry of exhaust gases or would not adequately support vehicle occupants or cargo.

(3) No motor vehicle body may be raised above the frame more than 4 inches beyond the original manufacturer's specifications. In the absence of such specifications, and on homemade and reconstructed vehicles, no body may be mounted with the floor pan more than 4 inches above the frame.

(c) Subchapter IV applies to heavy trucks, trailers and semi-trailers.

(3) Homemade or reconstructed vehicles registered in Wisconsin on or after January 1, 1975, shall meet the vehicle equipment standards in subchs. II, III and IV applicable to vehicles of the same type which are manufactured in the year in which the homemade or reconstructed vehicle is first registered in Wisconsin except as specifically provided. When subchs. II, III and IV make equipment standards applicable to vehicles manufactured after a certain date, the standards apply to homemade and reconstructed vehicles first registered in Wisconsin after that date.

(4) Vehicles covered under subchs. II, III and IV that are street modified or replica vehicles shall meet the following vehicle equipment requirements:

(a) The vehicle equipment requirements for a street modified vehicle shall be the same as the vehicle equipment requirements for a vehicle of the same type and model year that is not a street modified vehicle.

(b) The vehicle equipment requirements for a replica vehicle shall be the same as the vehicle equipment requirements for a vehicle of the same type and model year as the vehicle used for purposes of the reproduction.

~~(c) Street modified or replica vehicles in which an engine manufactured after January 1, 1968, is installed shall comply with s. Trans 305.20(7) and (8).~~

(5) No section of this chapter requires vehicles meeting equipment requirements established by Wisconsin or federal law for the year of original manufacture to update vehicle equipment to meet increased requirements under this chapter unless updating is required by ch. 347, Stats., or sub. (3).

(6) Vehicles that were legally titled and registered in another jurisdiction and that met vehicle equipment standards established by the law of the other jurisdiction shall not

(5) The tail pipe shall extend to the outside body line of the vehicle, except that light trucks may have the exhaust outlet extend only to the rear of the vehicle cab if the cargo area is not enclosed and used for passenger transportation.

(6) The exhaust system shall not be modified so as to pass through the passenger compartment.

(7) All air pollution control equipment required by the federal clean air act and its implementing regulations shall remain installed or be replaced with identical or comparable tested parts. ~~Engines manufactured since January 1, 1968, that are installed in homemade, reconstructed, replica or street modified vehicles shall have the original or identical or comparable tested air pollution control equipment in operation.~~ Air pollution control equipment originally installed by the manufacturer or identical or comparable tested replacement equipment may not be removed, disconnected or physically altered to be ineffective.

(8) All air pollution control equipment required under sub. (7) shall be maintained in proper working condition and in conformity with s. 144.42(6), Stats.

TRANS 305.21 FLOOR PAN AND FIREWALL. (1) The floor pan of every motor vehicle shall be maintained in good condition and in conformity with this section.

(2) The floor pan shall be free of rusted areas or holes which may allow entry of exhaust gases or would not adequately support vehicle occupants or cargo.

(3) No motor vehicle body may be raised above the frame more than 4 inches beyond the original manufacturer's specifications. In the absence of such specifications, and on homemade and reconstructed vehicles, no body may be mounted with the floor pan more than 4 inches above the frame.